

Panasonic[®]

Operating Instructions

Flash

Model No. **DMW-FL500**

LUMIX

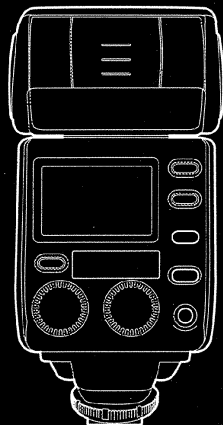
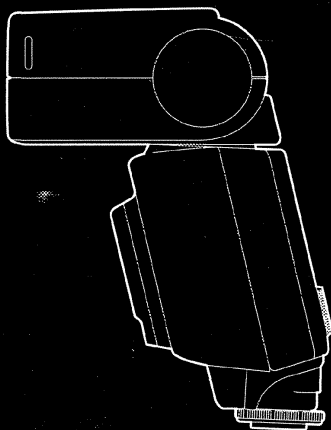

Before connecting, operating or adjusting this product, please read the instructions completely.

For USA assistance, please call: 1-800-272-7033 or send e-mail to : digitalstillcam@panasonic.com

For Canadian assistance, please call: 1-800-561-5505 or visit us at www.panasonic.ca

Contents

Information for Your Safety	3
Precautions	4
Supplied accessories	4
Names of the Components	5
Displays Appearing on the Display Panel	6
Concerning the batteries	7
Inserting and Removing the Unit's Batteries (optional)	10
Checking the Flash's Remaining Battery Charge	11
Mounting the Unit onto the Digital Camera, and Removing it	12
Taking Pictures using a Digital Camera with Communication Functions	13
How to select the flash mode	13
[TTL AUTO]	14
[AUTO]	15
[MANUAL]	16
[FP TTL AUTO]	17
[FP MANUAL]	18
Taking Pictures using a Digital Camera without Communication Functions	20
How to select the flash mode	20
[AUTO]	21
[MANUAL]	23
Other Applications	25
Taking pictures with bounce lighting	25
Taking pictures at close range	26
Selecting the lighting angle manually	26
How to use the Wide Panel	27
Many choices for different flash photography applications	28
Functions	29
Concerning Continuous Firing	31
Table of Guide Numbers (GN)	32
Troubleshooting	34
Cautions for Use	36
Specifications	38
Limited Warranty	39
Spanish Quick Use Guide/Guía rápida en español	42

Information for Your Safety

IMPORTANT SAFETY INSTRUCTIONS

When using your photographic equipment, basic safety precautions should always be followed, including the following:

- Read and understand all instructions before using.
- Close supervision is necessary when any appliance is used by or near children. Do not leave appliance unattended while in use.
- Care must be taken as burns can occur from touching hot parts.
- Do not operate if the appliance has been dropped or damaged - until it has been examined by qualified service personnel.
- Let appliance cool completely before putting away.
- To reduce the risk of electric shock, do not immerse this appliance in water or other liquids.
- To reduce the risk of electric shock, do not disassemble this appliance, but take it to qualified service personnel when service or repair work is required. Incorrect reassembly can cause electric shock when the appliance is used subsequently.
- The use of an accessory attachment not recommended by the manufacturer may cause a risk of fire, electric shock, or injury to persons.

SAVE THESE INSTRUCTIONS

FCC Note: (U.S. only)

This equipment has been tested and found to comply with the limits for a Class B digital device, pursuant to Part 15 of the FCC Rules. These limits are designed to provide reasonable protection against harmful interference in a residential installation. This equipment generates, uses, and can radiate radio frequency energy and, if not installed and used in accordance with the instructions, may cause harmful interference to radio communications. However, there is no guarantee that interference will not occur in a particular installation. If this equipment does cause harmful interference to radio or television reception, which can be determined by turning the equipment off and on, the user is encouraged to try to correct the interference by one or more of the following measures:

- Reorient or relocate the receiving antenna.
- Increase the separation between the equipment and receiver.
- Connect the equipment into an outlet on a circuit different from that to which the receiver is connected.
- Consult the dealer or an experienced radio/TV technician for help.

FCC Caution: To assure continued compliance, follow the attached installation instructions. Any changes or modifications not expressly approved by the party responsible for compliance could void the user's authority to operate this equipment.

This device complies with Part 15 of the FCC Rules. Operation is subject to the following two conditions: (1) This device may not cause harmful interference, and (2) this device must accept any interference received, including interference that may cause undesired operation.

(Canada only)

This Class B digital apparatus complies with Canadian ICES-003.

- This flash is designed to be used with digital cameras made by Panasonic. It is compatible with DMC-L1K (with communication functions: P13 to 19), DMC-FZ30 etc. (without communication functions: P20 to 24). (as of July 2006)
- The explanations in these operating instructions describe DMC-L1K as an example.
- Four Thirds™ is a trademark.
- When taking photos on rainy days or on a beach, take care to keep the unit dry.
- **The unit is not waterproof. If rain or drops of water splash onto the unit, wipe off the water with a dry cloth. If the unit does not operate normally, consult the dealer or your nearest servicenter.**
- Read the operating instructions for your digital camera.

WARNING

TO REDUCE THE RISK OF FIRE OR SHOCK HAZARD AND ANNOYING INTERFERENCE, USE ONLY THE RECOMMENDED ACCESSORIES AND DO NOT EXPOSE THIS EQUIPMENT TO RAIN, MOISTURE, DRIPPING OR SPLASHING. DO NOT REMOVE THE COVER (OR BACK); THERE ARE NO USER SERVICEABLE PARTS INSIDE. REFER SERVICING TO QUALIFIED SERVICE PERSONNEL.

-If you see this symbol-

Information on Disposal in other Countries outside the European Union

This symbol is only valid in the European Union. If you wish to discard this product, please contact your local authorities or dealer and ask for the correct method of disposal.

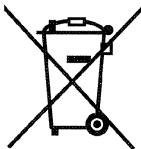

Precautions

- **Concerning the unit's handling**
- **Do not subject the unit to strong vibration or impact.** Doing so may cause not only the unit to malfunction but also the flash head to break.
- Before carrying the unit around with you, ensure that the wide panel is properly retracted. (P27)
- **Sand and dirt may cause the unit to malfunction. When using the unit in an environment such as a beach, take steps to protect it from sand and dirt.**

- **When the unit is not going to be used for a prolonged period**

- Be absolutely sure to remove the batteries from the unit.
- If the batteries are left inside the unit, a faint current will flow continuously, even when the unit's power is off, gradually discharging the batteries. (For details on nickel metal hydride batteries, refer to P9.)
- Store the batteries in a cool, moisture-free location where the temperature is kept as constant as possible. (Recommended temperature range: 15 °C to 25 °C; recommended humidity range: 40% to 60%)
- If you plan to store the unit and/or its batteries inside a closet or cupboard, it is recommended that you put a desiccant (silica gel) in with them.

Supplied accessories

[Inspection to be performed when you unpack the unit]

When removing the unit from its packing box, check that the main unit and its supplied accessories are present, and also check their external appearance and functions to verify that they have not sustained any damage during distribution and transportation.

If you discover any trouble, contact your vendor before using the product.

For this flash, use only the flash case shown below.

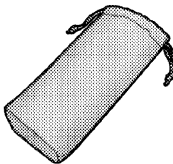

Flash case
VFC4216

- The batteries are optional.

Names of the Components

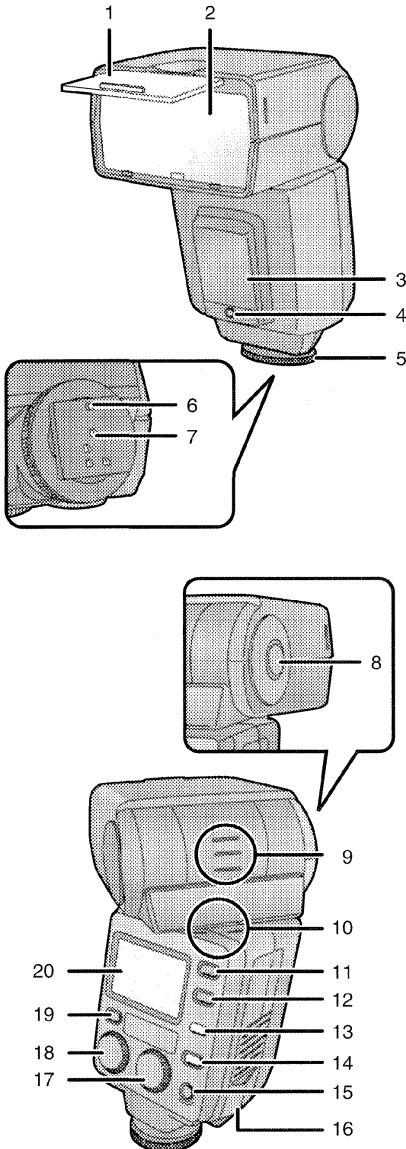

- 1 Wide panel (P27)
- 2 Flash head
- 3 AF assist lamp (P30)
 - In dark locations where it is difficult to bring the subject into focus, you can direct light onto the subject to facilitate focusing. (The AF assist works only when this flash is used in combination with Panasonic's "Four Thirds™" digital single-lens reflex camera: it will not work with other cameras.)
- 4 Flash sensor
- 5 Lock ring (P12)
- 6 Lock pin (P12)
- 7 Terminal area (P12)
- 8 Bounce unlock button (P12, 25)
- 9 Bounce up/down angle display (P25)
- 10 Bounce left/right angle display (P25)
- 11 [MODE] button (P13, 20 , 29)
- 12 [ZOOM] button (P21, 23 , 26 , 27)
- 13 [AUTO CHECK] lamp (P11, 14 , 21)
- 14 [TEST/CHARGE] button (P11, 13 20)
- 15 [POWER] button (P11, 13 20 29)
- 16 Battery cover (P10)
- 17 [F] dial (P19, 21 , 29)
- 18 [GN/ISO] dial (P16, 21 , 23 , 29)
- 19 [LIGHT] button (P29)
 - The display panel will light for about 15 seconds. It can also be lighted by operating a digital camera with communication functions.
- 20 Display panel (P6)

Displays Appearing on the Display Panel

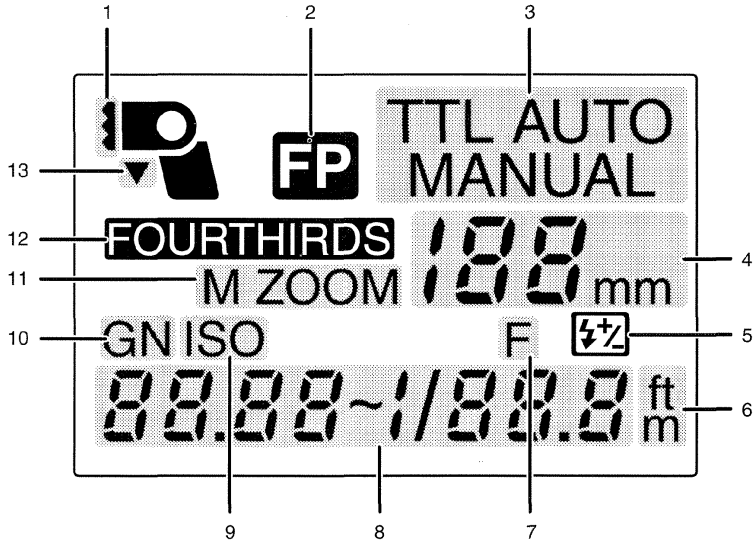

- | | |
|---|--|
| <ul style="list-style-type: none"> 1 Wide panel display (P27) 2 FP firing (P17, 18) 3 Flash mode (P13, 20) 4 Zoom value (P26) 5 Flash intensity adjustment (P19) 6 Distance display (P30) 7 Aperture 8 Setting displays
(guide number, ISO sensitivity, aperture,
flash working range, correct distance, flash
intensity adjustment) 9 ISO sensitivity 10 Guide number (GN) (P32) | <ul style="list-style-type: none"> 11 ZOOM mode (P26) 12 Lighting angle display (P30) <ul style="list-style-type: none"> • [FOUR THIRDS]:
The lighting angle is displayed by the
focal length of the "Four Thirds" digital
camera format lens. • [135]:
The lighting angle is converted into the
focal length of the 135 camera (35 mm
film conversion) and displayed. 13 Close-up flash (P26) |
|---|--|

Concerning the batteries

■ Types of batteries that can be used

AA Alkaline dry batteries (LR6)

AA Rechargeable nickel metal hydride batteries (Ni-MH)

- The use of batteries made by Panasonic is recommended.
- The performance of the batteries used may significantly differ depending on which battery brand is used, how long the batteries have been stored since they were manufactured and how they have been stored.
- The performance of the batteries decreases temporarily at low temperatures (below 10 °C), but will be restored when the temperature returns to room temperature.
- Malfunctioning may occur under certain ambient temperatures and operating conditions. However, this is not indicative of trouble.
- In order to ensure that the batteries will function for as long as possible, it is recommended that you turn off the unit's power during the intervals between taking photos. If the unit is to be used for prolonged periods, the use of rechargeable nickel metal hydride batteries is recommended.
- Once spent, batteries may recover their performance when left standing for a while, but they will quickly become unusable again. For this reason, always make a point of replacing spent batteries with fresh ones.

■ Types of batteries with which operation is not guaranteed

AA Ni-Cd batteries

AA Nickel-manganese batteries (ZR6)

AA Lithium batteries (FR6)

AA Manganese batteries (R6)

AA Oxyride (oxy-nickel-hydroxide) dry batteries (LR6)

CR-V3 Lithium battery packs

- Panasonic offers no guarantees that the unit will operate properly when any of the batteries listed above are used. Furthermore, use of these batteries may result in electrolyte leakage, power-on failures and other trouble.

■ Batteries with shapes that cannot be used

- Installing batteries with non-regular shapes in the unit may cause electrolyte leakage, heat generation and even rupturing of the batteries themselves.
- Some batteries sold on the market have part or all of their jackets missing: Under no circumstances should such batteries be used. (Refer to the figure below.)

- Batteries (bare batteries) with no external jackets or batteries with parts of their jackets missing

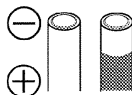

- Batteries whose \ominus electrode is flat



■ Handling the batteries

Mishandling of batteries may cause electrolyte leakage, heat generation and even rupturing of the batteries themselves. Heed with the following cautions.

- Do not expose batteries to water or seawater or allow their terminal areas to become wet.
- Do not remove their external jackets or damage them in any way.
- Do not drop the batteries, knock them into other objects or subject them to any other kind of strong impact.
- Stop using the batteries as soon as you notice any electrolyte leakage, deformation, discoloration or any other such trouble.
- Do not store batteries in locations where the temperature and/or humidity levels are high.
- Keep batteries out of the reach of infants and small children.
- When replacing the batteries, replace all four batteries with fresh batteries of the same type.
- Remove the batteries from the unit when you do not intend to use the unit for a prolonged period.
- Batteries may be hot immediately after the unit has been used. Before removing them from the unit, turn off the unit's power and wait until the temperature of the batteries has dropped.
- At low temperatures (under 10 °C), the performance of batteries will deteriorate and the number of flashes fired by the unit will be sharply reduced. The operating duration of batteries tends to be shorter particularly when alkaline dry batteries are used so warm them in your pocket before use. When warming batteries in your pocket, avoid direct contact with cigarette lighters and other metal objects as well as with pocket/body warmers.
- The number of flashes fired by the unit may also be sharply reduced if the ⊕ and ⊖ electrodes of the batteries are exposed to oils from the skin or other forms of dirt. Before installing the batteries, wipe the ⊕ and ⊖ electrodes carefully using a soft, dry cloth.

If electrolytes should leak from the batteries, wipe away all traces of the electrolyte in the battery compartment, and then insert fresh batteries or fully charged nickel metal hydride batteries.

If you should get electrolyte on your hands or clothes, rinse it off thoroughly with water. If you should get electrolyte in your eyes, you risk losing your sight. In such a case, do not rub your eyes but immediately wash them with clean water, and then seek medical advice.

■ Rechargeable nickel metal hydride batteries

Nickel metal hydride batteries can be made ready for use by recharging them using a dedicated charger. However, mishandling may cause electrolyte leakage, heat generation, the ignition of flames and even rupturing of the batteries themselves. Heed the following precautions.

- It may not be possible to properly recharge batteries with dirty ⊕ and ⊖ electrodes. Use a soft, dry cloth to carefully wipe the ⊕ and ⊖ electrodes as well as the terminal areas of the charger.
- Either when they are purchased or when they have not been used for a prolonged period, nickel metal hydride batteries may not have a sufficient charge. This is due to their characteristics and is not indicative of trouble. Their regular performance will be restored after they have been charged a number of times.
- It is recommended that the batteries be recharged only after their existing charge has been used up. If they are repeatedly charged without their existing charge first having been used up, it may be difficult for them to sustain their capacity. (A phenomenon referred to as the memory effect.)
- If the memory effect has occurred, use up the existing charge in the batteries until the unit cannot fire and then recharge them fully a number of times. This will restore their capacity.
- When nickel metal hydride batteries are not being used, their capacity will diminish due to the effects of natural discharging.
- Do not continuously charge nickel metal hydride batteries which already have a charge.
- Do not remove their external jackets or damage them in any way.
- Read the instructions accompanying the charger used when recharging the batteries.

Nickel metal hydride batteries have a specific service life. As they are increasingly used or as time goes by, their capacity will diminish gradually. When the length of time during which the unit can be used has dropped drastically, the batteries may have reached the end of their service life. Obtain fresh batteries.

- The length of the service life of batteries differs depending on their storage method, operating conditions and the environment in which they are used.

■ When the unit is not going to be used for a prolonged period

- If the batteries are left inside the unit, a faint current will flow continuously, even when the unit's power is off, gradually discharging the batteries. If they are left like this, they may overdischarge and may become unusable even when recharged.
- When storing the batteries for a prolonged period, it is recommended that they be charged once a year and that after their remaining charge has been used up, they be removed from the unit and stored again.

■ Service life of batteries

Number of flashes

(number of full flashes in MANUAL mode at intervals of 30 seconds)

Batteries used	Number of flashes
Alkaline dry batteries (LR6)	At least 120 flashes
Nickel metal hydride batteries (Ni-MH)	At least 140 flashes

Photo taking conditions

- Temperature: 23 °C

Flash interval

Batteries used	Flash interval
Alkaline dry batteries (LR6)	Approx. 6 s
Nickel metal hydride batteries (Ni-MH)	Approx. 4 s



- The number of flashes and flash interval differ slightly depending on the storage status of the batteries and the operating conditions.

Inserting and Removing the Unit's Batteries (optional)

- Check that the unit's power is off.
- Use alkaline dry batteries or rechargeable nickel metal hydride batteries.

1 Slide the battery cover to open it.

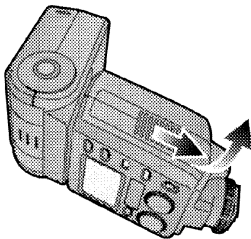

- There is tape adhered to the battery cover the first time that you use the unit. Peel it off.

2 When inserting the batteries, ensure that the \oplus and \ominus poles of the batteries are aligned correctly.

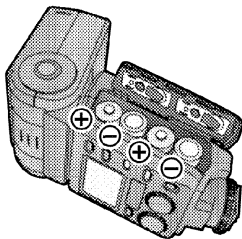

3 Close the battery cover by sliding it back firmly as far as it will go.

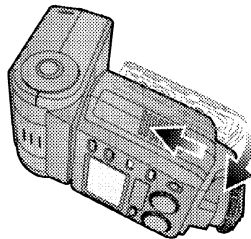

- After using the unit, take out the batteries.

Checking the Flash's Remaining Battery Charge

- Install the batteries and then turn on the unit and check the battery remaining power.

1 Push the [POWER] button.

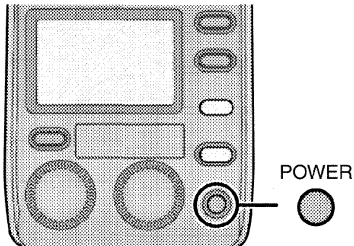

- Charging now starts.

2 Check that the [TEST/CHARGE] button lights.

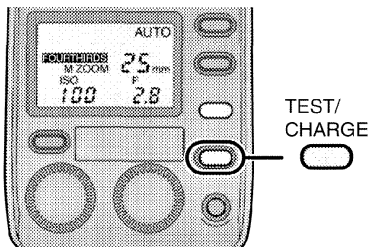

- After the batteries have been fully charged, the [TEST/CHARGE] button lights.
- If it takes as long for the [TEST/CHARGE] button to light as the period indicated in the table below, it means that the batteries are nearly worn out. Replace them with fresh batteries as soon as possible.

Alkaline batteries	More than 30 s
Rechargeable nickel metal hydride batteries	More than 10 s

- If the [TEST/CHARGE] button and [AUTO CHECK] lamp both flash at the same time, it means that the batteries are almost completely worn out and should be replaced with fresh batteries as soon as possible.

3 Push the [POWER] button to turn off the unit's power.



- When the [TEST/CHARGE] button is pushed, the unit may fire.
- Turn off the power in the following situations:
 - When mounting the unit onto, or disengaging it from, the digital camera
 - When you do not want the unit to fire
 - When you are not going to use the unit

Mounting the Unit onto the Digital Camera, and Removing it

- Check that the power of the digital camera and unit is off. (Mounting the unit onto, or disengaging it from, the camera while the power is on may cause trouble and is not recommended.)

■ Mounting the unit

1 Secure the flash head at the horizontal front position.

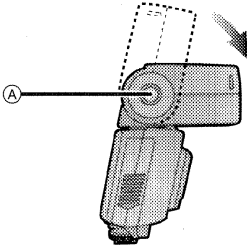

Ⓐ: Bounce unlock button

- If the flash head is at the lock position, rotate it while pushing the bounce unlock button.

2 Loosen the lock ring.

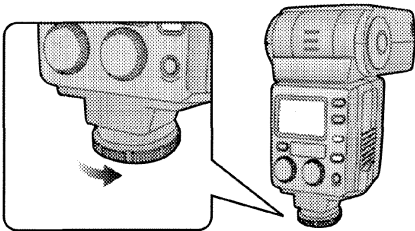

- If the lock pin is protruding, turn the lock ring in the opposite direction from [◀LOCK] and retract the pin.
- Do not apply more force than is necessary to the lock ring.
- Do not touch the terminal areas with your fingers, metal objects, etc.
- Do not mount the unit onto the digital camera while the lock pin is protruding. Otherwise you may damage the unit.

3 Slide the unit firmly toward the back of the hot shoe until a clicking sound is heard.

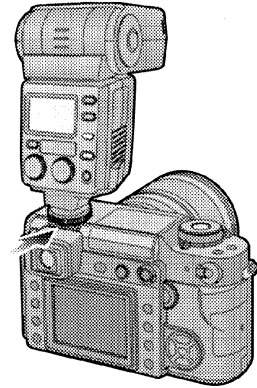

4 Turn the lock ring in the [◀LOCK] direction until it stops turning.

■ Removing the unit

Completely loosen the lock ring, and slide the unit off from the hot shoe.

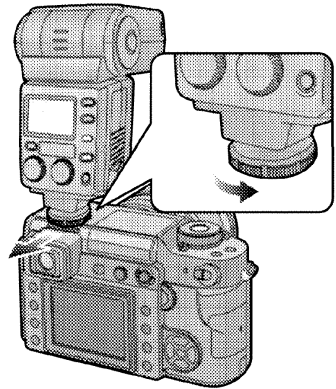

Taking Pictures using a Digital Camera with Communication Functions

How to select the flash mode

- For details on each flash mode, turn to P14 to 18.

- 1 Turn on the power of the digital camera.
- 2 Push the [POWER] button on the unit.

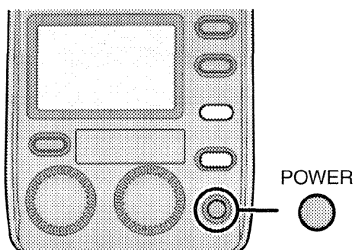

- The [TEST/CHARGE] button lights after the batteries have been fully charged.

- 3 Push the shutter button of the digital camera halfway down.
 - The ISO sensitivity, aperture, shutter speed and other photo taking information are sent between the digital camera and the unit.
- 4 Push the [MODE] button, and select the flash mode.

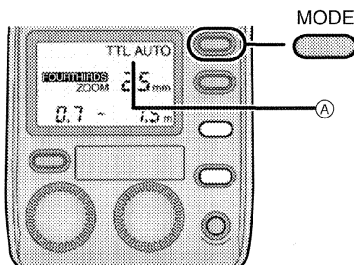

(A): Flash mode

- The flash mode is shown on the display panel.
- The mode is changed each time the [MODE] button is pushed.

Concerning the flash modes

Item	Details of settings
[TTL AUTO]	After measuring the appropriate flash intensity by discharging a pre-flash, the unit fires again for photo taking. (P14)
[AUTO]	The unit senses the light by its flash sensor in accordance with the aperture of the lens, and it adjusts the flash intensity. (P15) <ul style="list-style-type: none"> • This mode can be used only for digital camera models with communication functions which support the [AUTO] mode.
[MANUAL]	The unit fires at the guide number (GN)* which has been set. (P16)
[FP TTL AUTO]	This mode enables flash photo taking even at the high shutter speeds of the digital camera by FP firing (repeatedly firing the flash at high speed). (P17)
[FP MANUAL]	The unit initiates FP firing at the flash intensity set in the [FP MANUAL] mode. (P18)

* The guide number (GN) is a value which indicates the light quantity of a flash unit. The higher the value, the greater the quantity of light emitted by the unit.



- It may not be possible to use some of these modes depending on the photo taking modes which are supported by the digital camera.
- It is not possible to select a mode which cannot be used.

Push the [MODE] button, and select the flash mode. (P13)

- The flash working range is shown on the display panel in line with the settings of the digital camera.

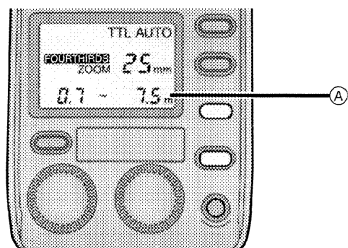

Ⓐ: Flash working range

1 Check that the distance to the subject is within the flash working range.

- If the subject is outside the range, adjust the aperture of the lens or change the distance to the subject.
- The flash working range changes depending on the type and settings (ISO sensitivity, aperture and focal length) of the digital camera used.

2 Push the shutter button all the way down, and take the picture.

3 Check that the [AUTO CHECK] lamp is flashing.

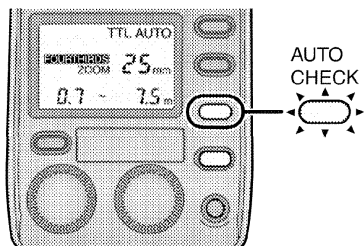

- If the [AUTO CHECK] lamp continues to flash for about 5 seconds, it means that the unit has fired successfully.

[AUTO]

Push the [MODE] button, and select the flash mode. (P13)

- The flash working range is shown on the display panel in line with the settings of the digital camera.

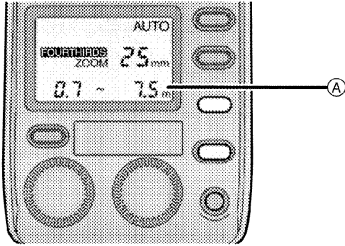

Ⓐ: Flash working range

- If the settings on the digital camera (ISO sensitivity and aperture) are outside the combinations of the ISO sensitivity and aperture which can be adjusted, the flash working range is not displayed and the user is warned by the flashing of [ISO] and [F] on the display. In a case like this, change the digital camera settings.

1 Check that the distance to the subject is within the flash working range.

- If the subject is outside the range, adjust the aperture of the lens or change the distance to the subject.
- The flash working range changes depending on the type and settings (ISO sensitivity, aperture and focal length) of the digital camera used.

2 Push the shutter button all the way down, and take the picture.

3 Check that the [AUTO CHECK] lamp is flashing.

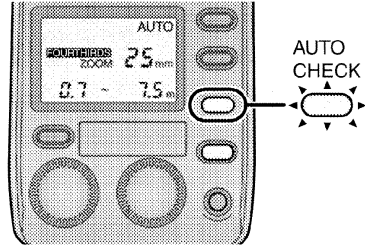

- If the [AUTO CHECK] lamp continues to flash for about 5 seconds, it means that the unit has fired successfully.

■ Combinations of the ISO sensitivity and aperture which can be adjusted in the [AUTO] mode

ISO sensitivity	Aperture
3200	F8 to F32
1600	F5.6 to F32
800	F4 to F32
400	F2.8 to F32
200	F2 to F32
100	F1.4 to F22
50	F1.4 to F16
25	F1.4 to F11

Push the [MODE] button, and select the flash mode. (P13)

- The optimum camera to subject distance and guide number (GN) matching the digital camera settings are shown on the display panel.

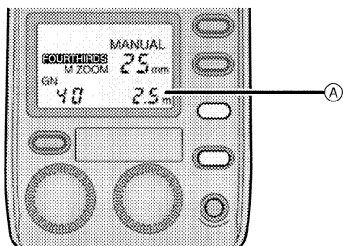

Ⓐ: Optimum camera to subject distance

- 1 Turn the [GN/ISO] dial and set the guide number (GN) so that the camera to subject distance is set to the distance the subject.

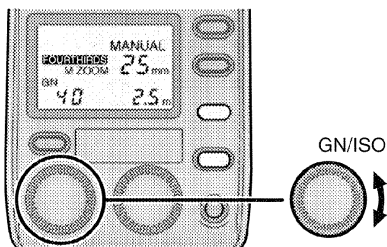

- The [F] dial can also be used for this setting. (P19)
- If the optimum camera to subject distance is closer than 0.6 m (or 0.5 m for close-up photos), the lighting range of the flash will shift. In this case, the user is warned by the flashing of the number on the display.
- The optimum camera to subject distance changes depending on the digital camera settings (ISO sensitivity, aperture, focal length and shutter speed).

- 2 Push the shutter button all the way down, and take the photo.



- If the ISO sensitivity is [100], the optimum camera to subject distance can be calculated by dividing the guide number (GN) by the aperture. (P32)

[FP TTL AUTO]

Push the [MODE] button, and select the flash mode. (P13)

- This mode enables flash photo taking even at the high shutter speeds of the digital camera by FP firing (repeatedly firing the flash at high speed).
- The flash working range is shown on the display panel in line with the settings of the digital camera.

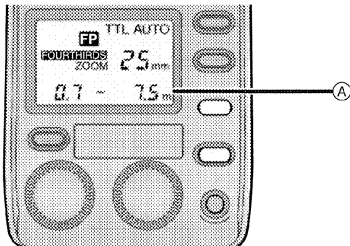

Ⓐ: Flash working range

1 Check that the distance to the subject is within the flash working range.

- If the subject is outside the range, adjust the aperture of the lens or change the distance to the subject.
- The flash working range changes depending on the type and settings (ISO sensitivity, aperture and focal length) of the digital camera used. The range is narrower than in the [TTL AUTO] mode.

2 Push the shutter button all the way down, and take the photo.

3 Check that the [AUTO CHECK] lamp is flashing.

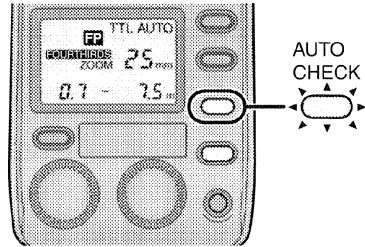

- If the [AUTO CHECK] lamp continues to flash for about 5 seconds, it means that the unit has fired successfully.

The following kinds of photos can be taken using high shutter speeds.

- Photo taking with the shadows softened by backlight photography



- Portrait photos taken outdoors with an open aperture and with the background defocused



Push the [MODE] button, and select the flash mode. (P13)

- The optimum camera to subject distance and guide number (GN) matching the digital camera settings are shown on the display panel.

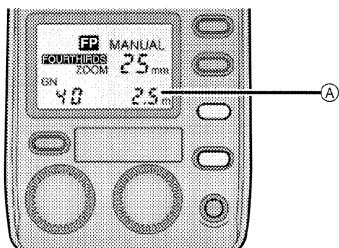

Ⓐ: Optimum camera to subject distance

- 1 Turn the [GN/ISO] dial and set the guide number (GN) so that the camera to subject distance is set to the distance to the subject.

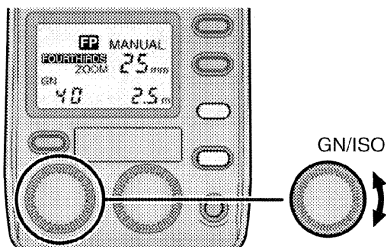

- The [F] dial can also be used for this setting.
- If the optimum camera to subject distance is closer than 0.6 m (or 0.5 m for close-up photos), the lighting range of the flash will shift. In this case, the user is warned by the flashing of the number on the display.
- The optimum camera to subject distance changes depending on the digital camera settings (ISO sensitivity, aperture, focal length and shutter speed).

- 2 Push the shutter button all the way down, and take the photo.

■ Adjusting the flash intensity

The flash intensity can be adjusted in steps. Set the flash intensity adjustment to [ON] before adjusting the flash intensity. (P30)

- [F] appears on the display panel.

1 Turn the [F] dial, and set the flash intensity adjustment value.

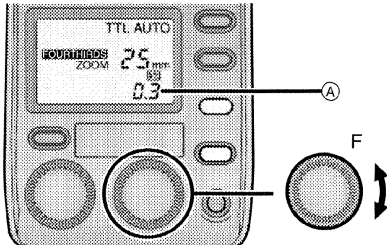

A: Flash intensity adjustment value

- The flash intensity adjustment value is always displayed except when it is [0]. If the flash intensity adjustment value is [0], the flash working range is not displayed.



The flash intensity adjustment range and the actual flash intensity may differ depending on the flash mode.

- Flash intensity adjustment range
 - If [TTL AUTO], [AUTO] or [FP TTL AUTO] is selected, the flash intensity can be adjusted over a range of ± 3.0 steps.

0 \rightarrow +0.3 \rightarrow +0.7 \rightarrow +1.0 \cdots +3.0

0 \rightarrow -0.3 \rightarrow -0.7 \rightarrow -1.0 \cdots -3.0

- If [MANUAL] or [FP MANUAL] is selected, the flash intensity can be adjusted over a range of ± 0.7 steps.

0 \rightarrow +0.3 \rightarrow +0.7

0 \rightarrow -0.3 \rightarrow -0.7

- The actual flash intensity may vary when the flash intensity adjustment value has been set on both the digital camera and the unit.
 - If [TTL AUTO], [AUTO] or [FP TTL AUTO] is selected, the unit fires at the adjustment value obtained by adding together the adjustment values set on the digital camera and the unit. (The value set on the unit only is displayed as the flash intensity adjustment value.)

[Example]

	Unit	Digital camera
Adjustment value setting	+0.3	+0.3 (+1/3 EV)
Unit's flash intensity adjustment value display	+0.3	
Actual adjustment value used for firing	+0.6 (+2/3 EV)	

- If [MANUAL] or [FP MANUAL] is selected, the unit fires at the adjustment value set on the unit only.

[Example]

	Unit	Digital camera
Adjustment value setting	+0.3	+0.3 (+1/3 EV)
Unit's flash intensity adjustment value display	+0.3	
Actual adjustment value used for firing	+0.3 (+1/3 EV)	

Taking Pictures using a Digital Camera without Communication Functions

How to select the flash mode

- For details on each flash mode, turn to P21 to 23.
- 1 Push the **[POWER]** button on the unit.
 - The **[TEST/CHARGE]** button lights after the batteries have been fully charged.
 - 2 Push the **[MODE]** button to select the flash mode.

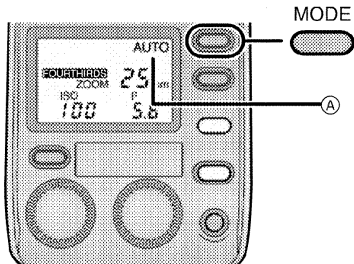

- Ⓐ: Flash mode
- The flash mode is shown on the display panel.
 - The mode is changed each time the **[MODE]** button is pushed.

■ Concerning the flash modes

Item	Details of settings
[AUTO]	The unit senses the light by its flash sensor in accordance with the aperture of the lens, and it adjusts the flash intensity. (P21)
[MANUAL]	The unit fires at the guide number (GN)* which has been set. (P23)

- * The guide number (GN) is a value which indicates the light quantity of a flash unit. The higher the value, the greater the quantity of light emitted by the unit.

[AUTO]

Push the [MODE] button, and select the flash mode. (P20)

1 Turn the [GN/ISO] dial to set the ISO sensitivity.

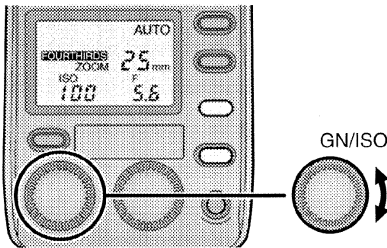

2 Push the [ZOOM] button to set the zoom value to the focal length of the lens.

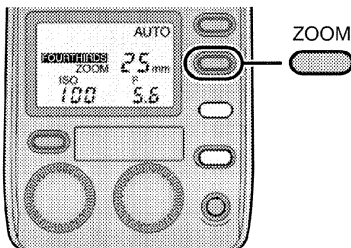

3 Turn the [F] dial and set it to the aperture of the lens.

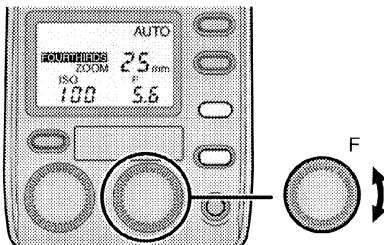

- If the combination of the ISO sensitivity and aperture are outside the usable range, a warning is given in the form of the flashing ISO sensitivity and aperture displays. In a case like this, change the ISO sensitivity and aperture.

4 Push the shutter button all the way down, and take the photo.

5 Check that the [AUTO CHECK] lamp is flashing.

- If the [AUTO CHECK] lamp continues to flash for about 5 seconds, it means that the unit has fired successfully.

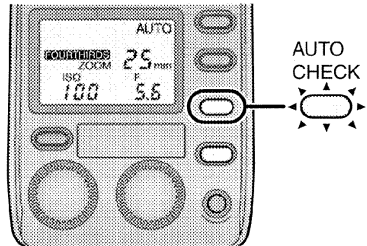

■ Flash working range in [AUTO] mode

ISO sensitivity								Lighting angle Focal length (mm) (35 mm film conversion)							
3200	1600	800	400	200	100	50	25	8 (16)	10 (20)	12 (24)	14 (28)	17 (35)	25 (50)	35 (70)	42 (85)
F8	F5.6	F4	F2.8	F2	F1.4	–	–	1.1 12.8	1.2 14.2	1.7 20.0	1.9 21.4	2.2 25.7	2.5 28.5	2.8 32.1	3.1 35.7
F11	F8	F5.6	F4	F2.8	F2	F1.4	–	0.8 9.0	0.9 10.0	1.2 14.0	1.3 15.0	1.6 18.0	1.7 20.0	2.0 22.5	2.2 25.0
F16	F11	F8	F5.6	F4	F2.8	F2	F1.4	0.5 6.4	0.6 7.1	0.8 10.0	0.9 10.7	1.1 12.8	1.2 14.2	1.4 16.0	1.5 17.8
F22	F16	F11	F8	F5.6	F4	F2.8	F2	0.5 4.5	0.5 5.0	0.6 7.0	0.6 7.5	0.8 9.0	0.8 10.0	1.0 11.2	1.1 12.5
F32	F22	F16	F11	F8	F5.6	F4	F2.8	0.5 3.2	0.5 3.5	0.5 5.0	0.5 5.3	0.5 6.4	0.6 7.1	0.7 8.0	0.7 8.9
–	F32	F22	F16	F11	F8	F5.6	F4	0.5 2.2	0.5 2.5	0.5 3.5	0.5 3.7	0.5 4.5	0.5 5.0	0.5 5.6	0.5 6.2
–	–	F32	F22	F16	F11	F8	F5.6	0.5 1.6	0.5 1.8	0.5 2.5	0.5 2.7	0.5 3.2	0.5 3.6	0.5 4.0	0.5 4.5
–	–	–	F32	F22	F16	F11	F8	0.5 1.1	0.5 1.2	0.5 1.7	0.5 1.8	0.5 2.2	0.5 2.5	0.5 2.8	0.5 3.1
–	–	–	–	F32	F22	F16	F11	0.5 0.7	0.5 0.8	0.5 1.2	0.5 1.3	0.5 1.5	0.5 1.7	0.5 1.9	0.5 2.2
Aperture values that can be set								Working range when taking pictures in [AUTO] (m)							



- The areas framed by the bold lines indicate the flash working range when the wide panel is used. (P27)
- When the flash head is facing toward the front, the number displayed at the near-distance side is 0.6 m or more, and when it is pointed downward, it is 0.5 m or more.
- The flash intensity can be adjusted in 1/3 steps by varying the ISO sensitivity and aperture from the digital camera settings.

[MANUAL]

Push the [MODE] button, and select the flash mode. (P20)

- The guide number (GN) and light quantity ratio appear on the display panel.

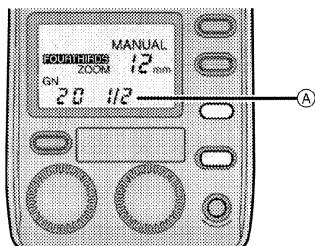

(A): Light quantity ratio

- The "light quantity ratio" is the ratio of the flash intensity to the full flash.

- 1 Push the [ZOOM] button to set the zoom value to the focal length of the lens.

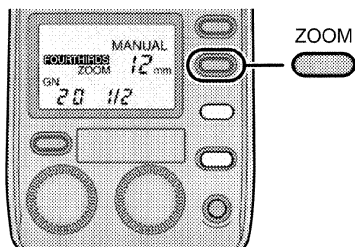

- 2 Turn the [GN/ISO] dial, and set the guide number (GN).

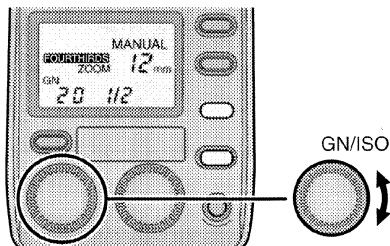

- The [F] dial can also be used for this setting.

- 3 Push the shutter button all the way down, and take the photo.

■ **How to determine the aperture and guide number**

When the camera to subject distance and aperture have been decided upon

- The following formula is used to obtain the guide number (GN), which is then set in the unit.

$$\text{"Aperture (F)" } \times \text{"Camera to subject distance (m)" } \\ \div \text{"ISO sensitivity coefficient"}$$

When the aperture is to be set

- The following formula is used to obtain the aperture, which is then set in the digital camera.

$$\text{"Guide number (GN)" } \times \text{"ISO sensitivity coefficient" } \\ \div \text{"Camera to subject distance (m)"}$$

How to obtain the optimum camera to subject distance

$$\text{"Guide number (GN)" } \times \text{"ISO sensitivity coefficient" } \\ \div \text{"Aperture (F)"}$$

ISO sensitivity coefficient

ISO sensitivity	Compensation coefficient
3200	5.6
1600	4.0
800	2.8
400	2.0
200	1.4
100	1.0
50	0.71
25	0.5

- For a list of guide numbers (GN), turn to P32.

Other Applications

Taking pictures with bounce lighting

- Bounce light photography is a technique which uses the reflected light from a ceiling or a wall onto which the light emitted from a flash unit has been directed.
- If the flash is aimed directly at the front of the subject when the portrait of a person is to be taken, for instance, strong shadows may form or the person's skin and other areas may appear whitish and indistinct.
- However, if the bounce light technique is used at times like this, the strong shadows can be minimized and the subject captured naturally.

1 While holding down the bounce unlock button, turn the flash head so that it is pointing in the desired direction.

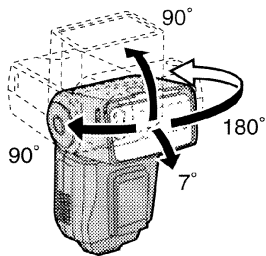

- At the locked position, change the direction while holding down the bounce unlock button.

2 Point the flash at the ceiling or other reflective surface, and take the photo.

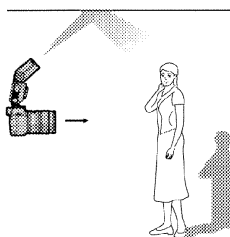

- The flash working range and optimum camera to subject distance do not appear on the display panel.
- When the lighting angle is set to [ZOOM] (auto), the zoom value appears on the display panel as [-] and 25 mm [135 camera (35 mm film conversion): 50 mm] is set.
- The lighting angle can be changed manually. (P26)



- When the [TEST/CHARGE] button is pushed, the [AUTO CHECK] lamp lights, and whether or not the firing is appropriate can be verified. (This is possible only when [AUTO] is established as the flash mode.)
- If the surface (such as the ceiling or walls) off which the light from the flash is to be reflected is colored, this may affect the photo images. Choose a surface which is white or off-white as the reflecting surface.

Taking pictures at close range

- When the camera to subject distance is 0.5 m to 1.5 m, the light emitted from the flash will be skewed. For this reason, while holding down the bounce unlock button, point the flash head downward (7 degrees), and then take the picture.

Point the flash head down as far as it will go (7 degrees downward).

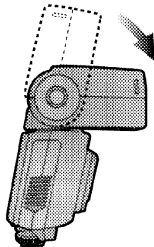

- [] appears on the display panel.



- Vignetting may be caused by the light from the flash when the lens has a long overall length or a large diameter. Take a test photo first, and then take the picture.
- Use the flash in this way only for close-up photos. If you keep the flash head pointed down during regular photo taking, the light emitted from the flash at the top of the screen will be insufficient.

Selecting the lighting angle manually

- The lighting angle can be adjusted manually.

Push the [ZOOM] button, and select the lighting angle.

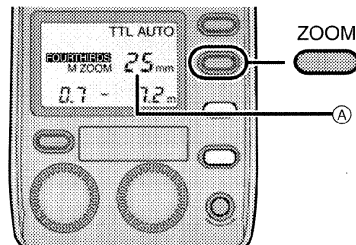

Ⓐ: Lighting angle

- [M ZOOM] appears on the display panel.

Any of the following ZOOM settings can be selected:

12 mm, 14 mm, 17 mm, 25 mm, 35 mm, 42 mm
[With a 135 camera (35 mm film conversion):
24 mm, 28 mm, 35 mm, 50 mm, 70 mm, 85 mm]

Each time the [ZOOM] button is pushed, the settings are selected in the following sequence:

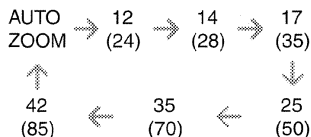

- [AUTO ZOOM] can be used only when a digital camera with communication functions is used.
- When the wide panel is used, any of the following settings can be selected: [AUTO ZOOM], [10 (20)] or [8 (16)].





- When a value higher than the focal length of the lens used is selected, the edges of the images will darken.

How to use the Wide Panel

- Use the built-in wide panel for flash photography when the focal length of the lens is wider than 12 mm.
- Set wide panel switching to [ON]. (P30)

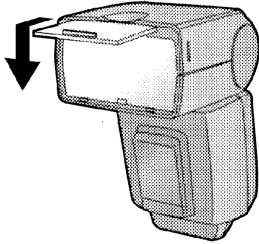
1 Pull out the wide panel and then push it down.



- [] appears on the display panel.

2 Push the [ZOOM] button, and select the lighting angle.

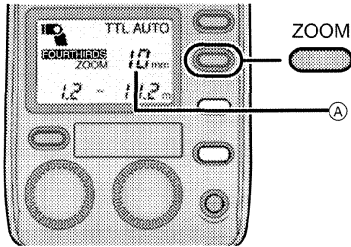

Ⓐ: Lighting angle

- 8 mm or 10 mm
[16 mm or 20 mm for a 135 camera
(35 mm film conversion)] can be selected.



- The angle cannot be displayed for a digital camera which does not have communication functions.
- When using the wide panel, the guide number (GN) is reduced. This means that the working range is reduced when taking photos in the [TTL AUTO], [AUTO] or [FP TTL AUTO] mode and that the optimum camera to subject distance is reduced when taking photos in the [MANUAL] or [FP MANUAL] range.
- After taking the photos, retract the wide panel.
- Do not push the wide panel upward. Otherwise it may be damaged.

Many choices for different flash photography applications

- Many different flash photography applications can be chosen by the digital camera settings.
- It may not be possible to use some functions depending on the functions and shape of the digital camera used.
- For further details, refer to the operating instructions of your digital camera.
- Select [TTL AUTO] or [FP TTL AUTO] as the flash mode.

Red-eye reduction flash

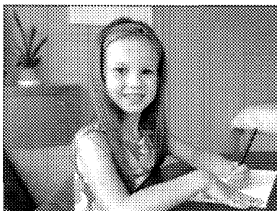

- The light emitted by the flash reduces red eye where the eyes of the subjects appear red.

Slow synchronization



- Light from the unit can be emitted using the slow shutter. This enables shots of people to be taken clearly against the backdrop of night scenes.

2nd curtain synchronization



- When taking slow-shutter shots of moving subjects, the flash is activated just before the shutter closes. Light sources emanating from behind the subject are captured to achieve a dynamic feeling.

Functions

- You can set each function in advance.

- 1 Push the [POWER] button.
- 2 Press the [MODE] button for 2 or more seconds to switch to the function settings.

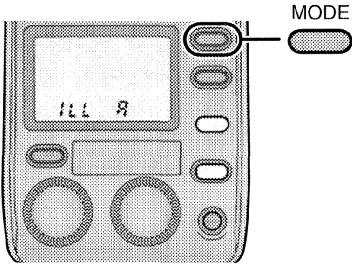

- 3 Turn the [GN/ISO] dial to select the menu item.

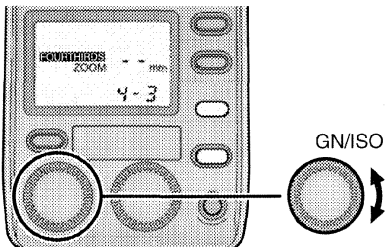

- 4 Turn the [F] dial to select the setting.

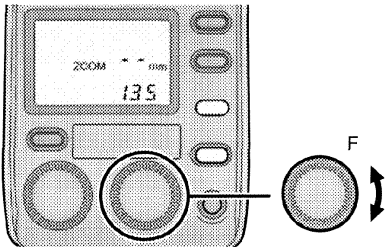

- 5 Push the [MODE] button to exit the settings.

- Returning the function settings to the default status (status at the time of purchase)

When the [MODE] button and [LIGHT] button are pushed together for two or more seconds, all the settings except for the distance display (m/ft) are returned to their defaults.

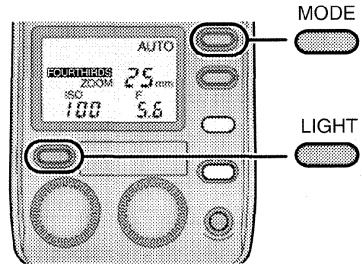

- The setting for the distance display (m/ft) remains unchanged.

Press the [MODE] button for 2 or more seconds to switch to the function settings. (P29)

Item		Setting	
	AF assist lamp	A:	The AF assist lamp lights, and focusing is facilitated.
		OFF:	The AF assist lamp does not light.

- AF assist will not work with digital cameras which are not part of Panasonic's "Four Thirds" system.

	Lighting angle	4-3:	The lighting angle is indicated by the focal length of the lens for the format used with the "Four Thirds" digital camera.
		135:	The lighting angle is converted into the focal length of a 35 mm film camera.

- 135 camera: This is a synonym for a 35 mm film camera format.

	Distance display	ft:	Distances are indicated in feet.
		m:	Distances are indicated in meters.

	Flash intensity adjustment	ON:	The flash intensity is adjusted.
		OFF:	The flash intensity is not adjusted.

	Wide panel switching	ON:	The wide panel takes effect. The unit recognizes that the wide panel is extended.
		OFF:	The wide panel has no effect.

Concerning Continuous Firing

When the flash is fired continuously, its flash head becomes hot, and this may possibly lead to deterioration or malfunction of the unit. Keep continuous firing within the number of times given below, and then allow the unit to rest for at least 10 minutes.

Restriction on number of flashes during continuous firing

Flash intensity	Flash interval	Restriction on number of flashes
1/1 (FULL)	1 s	10
1/2	0.5 s	20
1/4	0.3 s	40
1/8 to 1/128	0.2 s or less	80

Continuous firing is synchronized up to the number of frames listed below. If the restriction on the number of flashes during continuous firing is exceeded, allow the unit to rest for at least 10 minutes.

Number of frames for which continuous firing is possible (serial photography speed: 8 frames per second)

Light quantity	No. of frames
1/4	2
1/8	5
1/16	10
1/32	16
1/64	30
1/128	40

Table of Guide Numbers (GN)

[TTL AUTO]/[AUTO]

Lighting angle (mm)	FOUR THIRDS	8	10	12	14	17	25	35	42
		When a 135 (35 mm film conversion) camera is used	16	20	24	28	35	50	70
[TTL AUTO]/[AUTO]	Full flash	18	20	28	30	36	40	45	50

[MANUAL]

Lighting angle (mm)	FOUR THIRDS	8	10	12	14	17	25	35	42
		When a 135 (35 mm film conversion) camera is used	16	20	24	28	35	50	70
[MANUAL]	1/1	18	20	28	30	36	40	45	50
	1/2	13	14	20	21	26	28	32	35
	1/4	9.0	10	14	15	18	20	23	25
	1/8	6.4	7.1	9.9	11	13	14	16	18
	1/16	4.5	5.0	7.0	7.5	9.0	10	11	13
	1/32	3.2	3.5	4.9	5.3	6.4	7.1	8.0	8.8
	1/64	2.3	2.5	3.5	3.8	4.5	5.0	5.6	6.3
	1/128	1.6	1.8	2.5	2.7	3.2	3.5	4.0	4.4

[FP TTL AUTO]

Lighting angle (mm)	FOUR THIRDS	8	10	12	14	17	25	35	42
		When a 135 (35 mm film conversion) camera is used	16	20	24	28	35	50	70
Shutter speed	1/125	13	14	20	21	26	28	32	35
	1/160	11	13	18	19	23	25	28	32
	1/200	10	11	16	17	20	23	25	28
	1/250	9.0	10	14	15	18	20	23	25
	1/320	8.0	8.9	13	13	16	18	20	22
	1/400	7.1	7.9	11	12	14	16	18	20
	1/500	6.4	7.1	9.9	11	13	14	16	18
	1/640	5.7	6.3	8.8	9.4	11	13	14	16
	1/800	5.0	5.6	7.9	8.4	10	11	13	14
	1/1000	4.5	5.0	7.0	7.5	9.0	10	11	13
	1/1250	4.0	4.4	6.2	6.7	8.0	8.9	10	11
	1/1600	3.6	4.0	5.6	5.9	7.2	7.9	8.9	9.9
	1/2000	3.2	3.5	5.0	5.3	6.4	7.1	8.0	8.9
	1/2500	2.8	3.1	4.4	4.7	5.7	6.3	7.1	7.9
	1/3200	2.5	2.8	3.9	4.2	5.1	5.6	6.3	7.0
	1/4000	2.2	2.5	3.5	3.7	4.5	5.0	5.6	6.3
	1/5000	2.0	2.2	3.1	3.3	4.0	4.5	5.0	5.6
1/6400	1.8	2.0	2.8	3.0	3.6	4.0	4.5	5.0	
1/8000	1.6	1.8	2.5	2.7	3.2	3.5	4.0	4.4	

[FP MANUAL]

- Listed below are the guide numbers (GN) for 1/1 (FULL) flashes.

Lighting angle (mm)	FOUR THIRDS	8	10	12	14	17	25	35	42
	When a 135 (35 mm film conversion) camera is used	16	20	24	28	35	50	70	85
Shutter speed	1/125	13	14	20	21	26	28	32	35
	1/160	11	13	18	19	23	25	28	32
	1/200	10	11	16	17	20	23	25	28
	1/250	9.0	10	14	15	18	20	23	25
	1/320	8.0	8.9	13	13	16	18	20	22
	1/400	7.1	7.9	11	12	14	16	18	20
	1/500	6.4	7.1	9.9	11	13	14	16	18
	1/640	5.7	6.3	8.8	9.4	11	13	14	16
	1/800	5.0	5.6	7.9	8.4	10	11	13	14
	1/1000	4.5	5.0	7.0	7.5	9.0	10	11	13
	1/1250	4.0	4.4	6.2	6.7	8.0	8.9	10	11
	1/1600	3.6	4.0	5.6	5.9	7.2	7.9	8.9	9.9
	1/2000	3.2	3.5	5.0	5.3	6.4	7.1	8.0	8.9
	1/2500	2.8	3.1	4.4	4.7	5.7	6.3	7.1	7.9
	1/3200	2.5	2.8	3.9	4.2	5.1	5.6	6.3	7.0
	1/4000	2.2	2.5	3.5	3.7	4.5	5.0	5.6	6.3
1/5000	2.0	2.2	3.1	3.3	4.0	4.5	5.0	5.6	
1/6400	1.8	2.0	2.8	3.0	3.6	4.0	4.5	5.0	
1/8000	1.6	1.8	2.5	2.7	3.2	3.5	4.0	4.4	

- In the [FP MANUAL] mode, the following formula can be used to obtain the guide numbers (GN) when any setting except 1/1 is used for the light quantity.

How to obtain the guide number when the light quantity setting is other than 1/1

- Guide number (GN) = Guide number for 1/1 × light quantity ratio coefficient

Light quantity ratio coefficient

Light quantity ratio	1/1	1/2	1/4	1/8	1/16
Light quantity ratio coefficient	1.0	0.71	0.5	0.35	0.25



- The tables show the values when the ISO sensitivity is [100].

Troubleshooting

■ Q&A for the unit

Question (Q)	Answer (A)
The unit becomes hot.	When the unit is fired continuously immediately after the [TEST/CHARGE] button has lighted, the batteries will generate heat, but this does not pose any problems in terms of performance or quality. In cases like this, wait until the flash head and batteries cool off before resuming use.
I can't install the unit on my digital camera.	Is the lock pin protruding? You cannot install the unit on your digital camera if this pin is protruding. <ul style="list-style-type: none"> ● Turn the lock ring in the opposite direction from [◀LOCK] until it stops and retract the pin before proceeding to install the unit on the digital camera.
I can't select the flash modes even by pushing the [MODE] button.	When connecting the unit to some digital camera models capable of communication, you can select the flash's mode only from the digital camera.
The coloring of the images differs from what I see.	Adjust the white balance of the digital camera. (Setting to the [AUTO] mode is recommended.)
The flash working range does not appear on the display panel.	The flash working range is not displayed in the following cases: <ul style="list-style-type: none"> ● When the lens has been detached ● When bounce light photography is performed ● When the light intensity is adjusted ● When the ISO sensitivity or aperture setting is outside the range
The display panel is extinguished even though the unit's power is on.	Is the digital camera's power-saving function working? The flash is coupled to the digital camera so that when the digital camera's power-saving function is working, the flash's display panel will be extinguished. <ul style="list-style-type: none"> ● Push the digital camera's shutter button halfway down to release the function.
The flash's power does not go off even though I turned off the power of my digital camera which comes with communication functions.	When the power of a digital camera with communication functions is switched off, the flash is set to the power-saving mode. When the power of the digital camera is turned back on, the flash's power is also turned on. When the flash's power is to be turned off, turn off its power first. When the flash is used in combination with a digital camera without communication functions, it is automatically set to the power-saving mode when no operations have been performed for about 60 minutes.
I can't switch to the lighting angle.	Has the wide panel been damaged? <ul style="list-style-type: none"> ● If the wide panel is damaged while it is extended, you will no longer be able to use the [ZOOM] button. In this case, you can use the [ZOOM] button if you set wide panel switching to [OFF].

■ Q&A for the panel display

Question (Q)	Answer (A)
[ISO] and [F] are flashing or the numbers for the ISO sensitivity and aperture are flashing	This means that the ISO sensitivity and aperture of the digital camera are outside the flash working range of the flash. Change the ISO sensitivity and aperture of the digital camera.
The optimum camera to subject distance is flashing	The flash is too close to the subject. If the subject is too close, the lighting range of the flash will shift so take photos at a distance further than 0.6 m (or 0.5 m for close-up photos).
[] and the lighting angle are flashing	Extend the wide panel.
[] does not go off	The flash head has been set to point downward (7 degrees). Do not use this setting unless you are taking close-ups.
[] does not go off	The wide panel is extended. <ul style="list-style-type: none"> ● The guide number (GN) is reduced. Pay attention to the camera to subject distance.

Cautions for Use

■ Concerning the unit

- Avoid bringing the unit into close proximity with objects. Its heat and light may cause deformation or discoloration.
- When taking photos outside the flash working range, the proper exposure will not be achieved, and images which are whitish or too dark may be taken.
- At high shutter speeds, the effects obtained by the unit may not be sufficient.

Keep the unit away from insecticide sprays and other volatile substances.

- If the unit is exposed to these sprays or substances, its external case may deteriorate and/or its paint may peel off.
- Do not leave the unit in contact with any items made of rubber or PVC for prolonged periods of time.

Do not use benzine, paint thinners, alcohol or other such solvents to maintain the unit.

- Remove the batteries before proceeding with maintenance.
- Use of solvents may cause a deterioration in the unit's external case and/or the paint to peel off.
- Wipe away dust and fingerprints using a soft, dry cloth.
- Do not use kitchen detergents or chemical cleaning cloths.
- If rain or drops of water splash onto the unit, wipe off the water with a dry cloth.

Do not carry the unit when it is still attached to the camera body.

- Under no circumstances should the unit be stored in any of the following locations since doing so may cause trouble in operation or malfunctioning.
 - In direct sunlight or on a beach in summer
 - In locations with high temperatures and humidity levels or where the changes in temperature and humidity are acute
 - In locations with high concentrations of sand, dust or dirt
 - Where there is fire
 - Near heaters, air conditioners or humidifiers
 - Where water may make the unit wet
 - Where there is vibration
 - Inside a vehicle
- Multiple-light shots cannot be taken by using the flash in combination with other flash units.
- Do not drop the unit, knock it into other objects or subject it to any other kind of strong impact or shock.
- When the unit is not going to be used for a prolonged period, mold and other problems may cause failure of the unit. It is recommended that you check the unit's operation prior to use.
- Do not touch the unit's electrical contacts. Doing so can cause failure of the unit.
- To safeguard the flash head from overheating and deterioration, stop using the unit after 10 continuous firings at the full flash intensity, and allow the unit to rest for at least 10 minutes to ensure that the flash head cools off.

■ Concerning the batteries

Be sure to remove the batteries when you will not be using the camera for a long period of time.

- If the temperature is too high or low, the terminals may rust causing a malfunction.

If you drop the batteries accidentally, check to see if the body of the batteries or the terminals are damaged.

- Inserting a damaged battery in the camera will damage the camera.

Bring charged spare batteries when going out.

- Be aware that the operating time of the batteries becomes shorter in low temperature conditions such as at a ski resort.

Dispose of unusable batteries.

- Batteries have a limited life.
- Do not throw batteries into fire because they may cause an explosion.
- The unusable battery should be discarded in accordance with battery recycling laws. Call the RBRC hotline on 1-800-822-8837 for information.

Do not allow battery terminals to come into contact with metal objects (such as necklaces, hairpins, etc.).

- This can cause short circuiting or heat generation and you may be badly burned if you touch the batteries.

Do not attempt to recharge dry batteries.

Do not throw batteries into a fire or expose to excessive heat such as sunshine.

Specifications

Power requirements: DC 6.0 V

Batteries recommended for use	AA Alkaline dry batteries (LR6) × 4/ AA Rechargeable nickel metal hydride batteries (Ni-MH) × 4
Charging time (from full flash until the [TEST/CHARGE] button lights)	Max. 7 s: AA Alkaline dry batteries Max. 5 s: AA Rechargeable nickel metal hydride batteries
Firing period	Approx. 1/20000 s to 1/500 s (Varies depending on the flash intensity; FP firing excluded.)
No. of flashes (with full flash)	120 flashes or more: AA Alkaline dry batteries 140 flashes or more: AA Rechargeable nickel metal hydride batteries (Differs depending on the photo taking conditions.)
Flash modes	TTL AUTO/AUTO/MANUAL/FP TTL AUTO/FP MANUAL
Bounce angle	Upward: 0 to 90 degrees, downward: 0 to 7 degrees, toward the right: 0 to 90 degrees, toward the left: 0 to 180 degrees
Power-saving mode	Coupled to power-saving mode of a digital camera having communication capability
AF assist lamp	Only for combinations with digital camera having communication capability approximate distance enabling automatic lighting at low-brightness levels: 0.7 m to 7 m (Differs depending on the digital camera and type of lens used)
Guide number	Automatically selected 50: At 42 mm setting (85 mm when a 135 camera is used) 28: At 12 mm setting (24 mm when a 135 camera is used) 18/20 selected: When the wide panel is used
Lighting angle	Automatically selected At 12 mm setting: 61 degrees up/down, 78 degrees left/right (View angle of 12 mm lens covered)* At 42 mm setting: 21 degrees up/down, 28 degrees left/right (View angle of 42 mm lens covered)* Using wide panel: 83 degrees up/down, 101 degrees left/right (View angle of 8 mm lens covered)* * When "FOUR THIRDS" applies as the ZOOM display
Dimensions	Approx. 79.4 mm (W) × 141.1 mm (H) × 107.1 mm (D) (excluding the projecting parts)
Mass	Approx. 375 g (main unit) Approx. 455 g (including batteries)
Operating temperature	0 °C to 40 °C (32 °F to 104 °F)
Operating humidity	10% to 80% (no condensation)

Limited Warranty

FOR U.S.A.

**PANASONIC CONSUMER ELECTRONICS
COMPANY, DIVISION OF PANASONIC
CORPORATION OF NORTH AMERICA**
One Panasonic Way,
Secaucus, New Jersey 07094

PANASONIC PUERTO RICO, INC.
Ave. 65 de infantería, Km. 9.5,
San Gabriel Industrial Park,
Carolina, Puerto Rico 00985

Panasonic Digital Still Camera ACCESSORIES LIMITED WARRANTY

Limited Warranty Coverage

If your product does not work properly because of a defect in materials or workmanship, Panasonic Consumer Electronics Company or Panasonic Puerto Rico, Inc. (collectively referred to as "the warrantor") will, for the length of the period indicated on the chart below, which starts with the date of original purchase ("warranty period"), at its option either (a) repair your product with new or refurbished parts, or (b) replace it with a new or a refurbished product. The decision to repair or replace will be made by the warrantor.

For ninety (90) days—AC Adaptors, Flashes, Conversion Lenses, Filters, Lens Adaptors, Marine Cases

For ten (10) days—Batteries (Non-rechargeable batteries are not warranted.)

You must Mail-In your product during the warranty period. This warranty only applies to products purchased and serviced in the United States or Puerto Rico. This warranty is extended only to the original purchaser of a new product which was not sold "as is".

Mail-In Service

For assistance in obtaining service in the United States please contact:

Panasonic Services Company Panasonic Plus Department
20421 84th Avenue South
Kent, WA 98032
Phone: 1-800-833-9626
Fax: 1-800-237-9080

If repair is needed during the warranty period the purchaser will be required to furnish a sales receipt/ proof of purchase indicating date of purchase.

Also, purchaser will be responsible for shipping the unit to the above address.

For assistance in Puerto Rico call Panasonic Puerto Rico, Inc. (787)-750-4300 or fax (787)-768-2910.

Limited Warranty Limits And Exclusions

This warranty ONLY COVERS failures due to defects in materials or workmanship, and DOES NOT COVER normal wear and tear or cosmetic damage. The warranty ALSO DOES NOT COVER damages which occurred in shipment, or failures which are caused by products not supplied by the warrantor, or failures which result from accidents, misuse, abuse, neglect, mishandling, misapplication, alteration, faulty installation, set-up adjustments, misadjustment of consumer controls, improper maintenance, power line surge, lightning damage, modification, or commercial use (such as in a hotel, office, restaurant, or other business), rental use of the product, service by anyone other than a Factory Servicenter or other Authorized Servicer, or damage that is attributable to acts of God.

THERE ARE NO EXPRESS WARRANTIES EXCEPT AS LISTED UNDER "LIMITED WARRANTY COVERAGE". THE WARRANTOR IS NOT LIABLE FOR INCIDENTAL OR CONSEQUENTIAL DAMAGES RESULTING FROM THE USE OF THIS PRODUCT, OR ARISING OUT OF ANY BREACH OF THIS WARRANTY. (As examples, this excludes damages for lost time, travel to and from the servicer, or loss of, or failure to obtain, images, data or other camera memory content. The items listed are not exclusive, but are for illustration only.) ALL EXPRESS AND IMPLIED WARRANTIES, INCLUDING THE WARRANTY OF MERCHANTABILITY, ARE LIMITED TO THE PERIOD OF THE LIMITED WARRANTY.

Some states do not allow the exclusion or limitation of incidental or consequential damages, or limitations on how long an implied warranty lasts, so the exclusions may not apply to you. This warranty gives you specific legal rights and you may also have others rights which vary from state to state. If a problem with this product develops during or after the warranty period, you may contact your dealer or Servicenter. If the problem is not handled to your satisfaction, then write to the warrantor's Consumer Affairs Department at the addresses listed for the warrantor.

PARTS AND SERVICE WHICH ARE NOT COVERED BY THIS LIMITED WARRANTY ARE YOUR RESPONSIBILITY.

FOR CANADA

Panasonic Canada Inc.

5770 Ambler Drive, Mississauga, Ontario L4W 2T3

PANASONIC PRODUCT – LIMITED WARRANTY

Panasonic Canada Inc. warrants this product to be free from defects in material and workmanship and agrees to remedy any such defect for a period as stated below from the date of original purchase.

Digital Camera	One (1) year, parts and labour
Digital Photo Peripherals	One (1) year, parts and labour
Digital Camera Accessories	Ninety (90) days, parts and labour

LIMITATIONS AND EXCLUSIONS

This warranty does not apply to products purchased outside Canada or to any product which has been improperly installed, subjected to usage for which the product was not designed, misused or abused, damaged during shipping, or which has been altered or repaired in any way that affects the reliability or detracts from the performance, nor does it cover any product which is used commercially. Dry cell batteries, printer ink cartridge and paper are also excluded from coverage under this warranty. This warranty is extended to the original end user purchaser only. A purchase receipt or other proof of date of original purchase is required before warranty service is performed.

THIS EXPRESS, LIMITED WARRANTY IS IN LIEU OF ALL OTHER WARRANTIES, EXPRESS OR IMPLIED, INCLUDING ANY IMPLIED WARRANTIES OF MERCHANTABILITY AND FITNESS FOR A PARTICULAR PURPOSE.

IN NO EVENT WILL PANASONIC CANADA INC. BE LIABLE FOR ANY SPECIAL, INDIRECT OR CONSEQUENTIAL DAMAGES.

In certain instances, some jurisdictions do not allow the exclusion or limitation of incidental or consequential damages, or the exclusion of implied warranties, so the above limitations and exclusions may not be applicable.

WARRANTY SERVICE

For product operation and information assistance, please contact:

Our Customer Care Centre: Telephone #: (905) 624-5505
1-800 #: 1-800-561-5505
Fax #: (905) 238-2360
Email link: "Customer support" on www.panasonic.ca

FOR PRODUCT REPAIRS, please locate your nearest Authorized Servicentre at www.panasonic.ca:

Link : "Servicentres™ locator" under "Customer support"

IF YOU SHIP THE PRODUCT TO A SERVICENTRE

Carefully pack and send prepaid, adequately insured and preferably in the original carton.
Include details of the defect claimed, and proof of date of original purchase.

Panasonic Consumer Electronics Company,
Division of Panasonic Corporation of North America
One Panasonic Way, Secaucus, NJ 07094

Panasonic Puerto Rico, Inc.
Ave. 65 de Infantería, Km. 9.5, San Gabriel Industrial Park, Carolina, Puerto Rico 00985

Panasonic Canada Inc.
5770 Ambler Drive, Mississauga, Ontario, L4W 2T3

© 2006 Matsushita Electric Industrial Co., Ltd.



Spanish Quick Use Guide/ Guía rápida en español

■ Montar la unidad

- 1 Fije la cabeza del flash en la posición frontal horizontal.

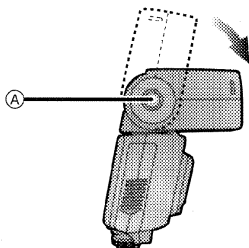

(A): Botón de desbloqueo del rebote

- Si la cabeza del flash está en la posición de bloqueo, gírela apretando el botón de desbloqueo del rebote.

- 2 Afloje el anillo de bloqueo.

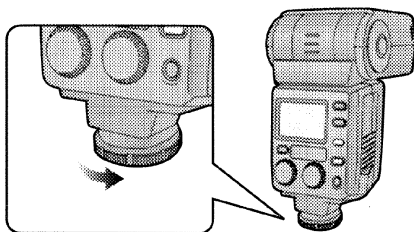

- Si la espiga de bloqueo sobresale, gire el anillo de bloqueo en la dirección opuesta de [◀LOCK] y retire la espiga.
- No aplique más fuerza que la necesaria al anillo de bloqueo.
- No toque los contactos terminales con sus dedos, objetos metálicos, etc.
- No monte la unidad en la cámara digital mientras sobresale la espiga de bloqueo. Si no puede causar una avería.

- 3 Desplace la unidad firmemente hacia la parte trasera de la zapata de contacto hasta que se oiga un clic.

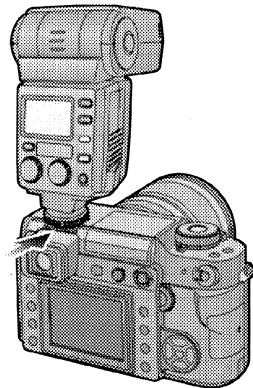

- 4 Gire el anillo de bloqueo en la dirección [◀LOCK] hasta que deje de girar.

■ Cómo seleccionar el modo flash

- 1 Encienda la alimentación de la cámara digital.

- 2 Pulse el botón [POWER] en la unidad.

- Se enciende el botón [TEST/CHARGE] después de que las baterías hayan sido enteramente cargadas.

- 3 Pulse a mitad el botón del obturador de la cámara digital.

- La sensibilidad ISO, la apertura, la velocidad de obturación y otra información sobre la toma de fotos se envían entre la cámara digital y la unidad.

4 Pulse el botón [MODE] y seleccione el modo flash.

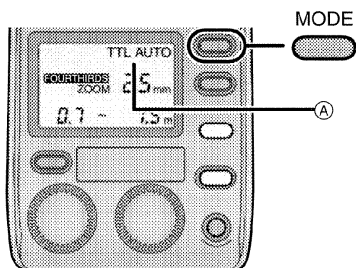

(A): Modo de flash

- El modo flash se muestra en el panel visualizador.
- El modo cambia cada vez que pulsa el botón [MODE].

■ [AUTO]

- La distancia de funcionamiento del flash se muestra en el panel visualizador en línea con los ajustes de la cámara digital.

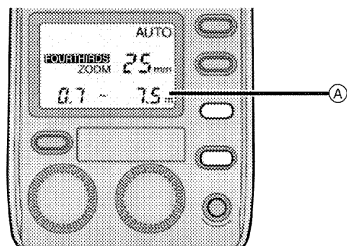

(A): Distancia de funcionamiento del flash

- Si los ajustes de la cámara digital (sensibilidad ISO y apertura) van más allá de las combinaciones de la sensibilidad ISO y la apertura que pueden ajustarse, la gama de funcionamiento del flash no se visualiza y el destello de [ISO] y [F] en la pantalla advierten al usuario. En este caso, cambie los ajustes de la cámara digital.

1 Compruebe que la distancia hasta el sujeto esté dentro de la gama de funcionamiento del flash.

- Si el sujeto está fuera de dicha gama, ajuste la apertura del objetivo o cambie la distancia hasta el sujeto.
- La distancia de funcionamiento del flash depende del tipo y los ajustes (sensibilidad ISO, apertura y longitud focal) de la cámara digital usada.

2 Pulse el botón del obturador a tope y tome la imagen.

3 Compruebe que la lámpara [AUTO CHECK] esté destellando.

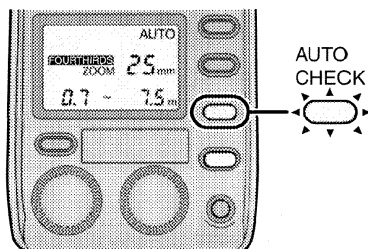

- Si la lámpara [AUTO CHECK] sigue destellando durante 5 segundos aproximadamente, eso quiere decir que la unidad ha disparado con éxito.